

**BOARD VARIATIONS:**

DB-SO8-LPC906 U1 = P89LPC906FD \*  
 DB-SO8-LPC907 U1 = P89LPC907FD \*  
 DB-SO8-LPC908 U1 = P89LPC908FD  
 (\*) NOT NORMALLY STOCKED, AVAILABLE  
 ON SPECIAL ORDER

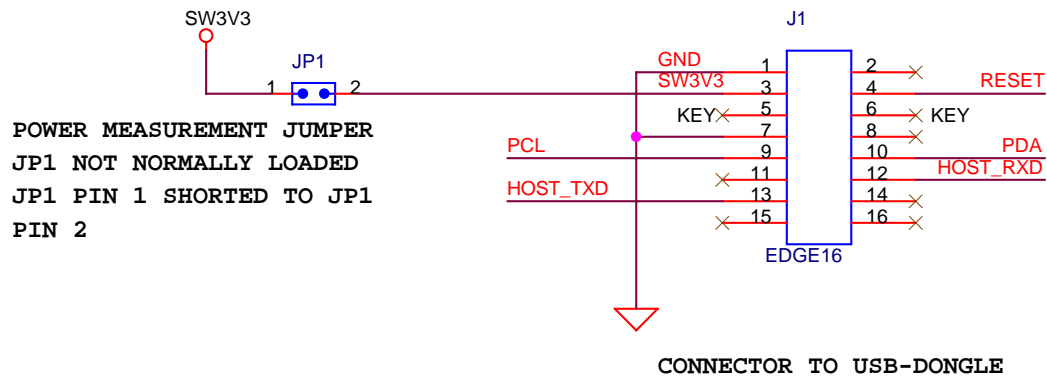
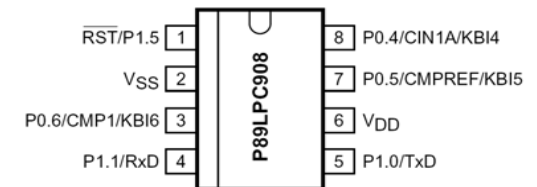
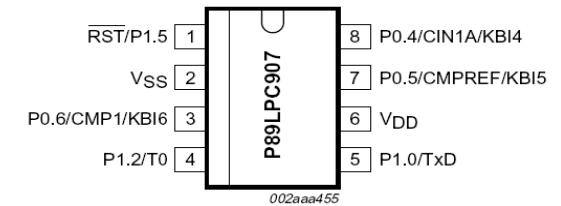
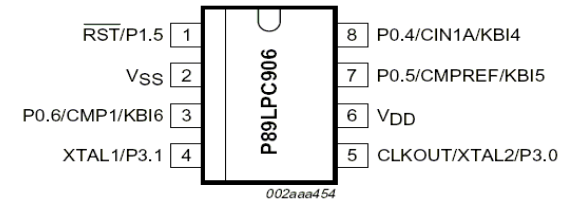
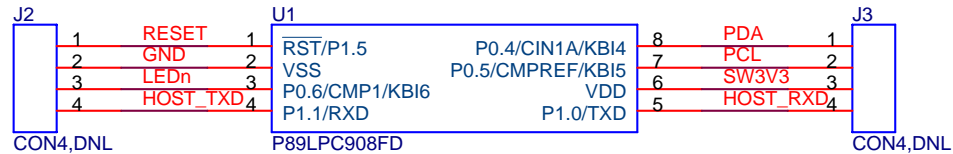

**POWER MEASUREMENT JUMPER**  
 JP1 NOT NORMALLY LOADED  
 JP1 PIN 1 SHORTED TO JP1  
 PIN 2

CONNECTOR TO USB-DONGLE

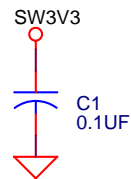
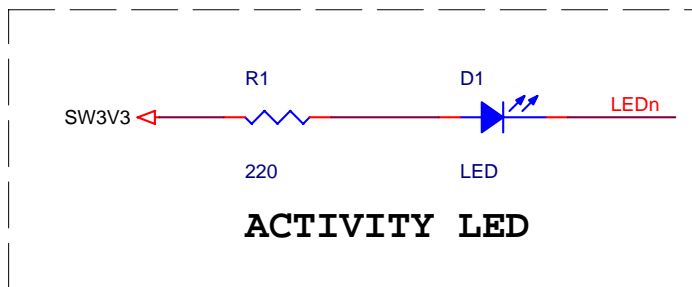
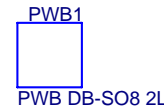

<b>Future Designs, Inc.</b> Huntsville, AL		
Title: DB-SO8		
Size:	Document Number:	Rev: 1
Date: Friday, May 18, 2007	Sheet: 1 of 1	