

OPTIONAL RESET CIRCUIT

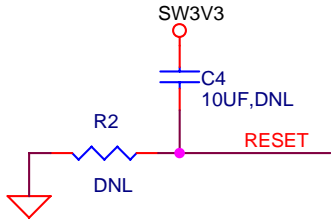

BOARD VARIATIONS:

DB-TQFP44-89V52X2 U1 = P89V52X2FBD

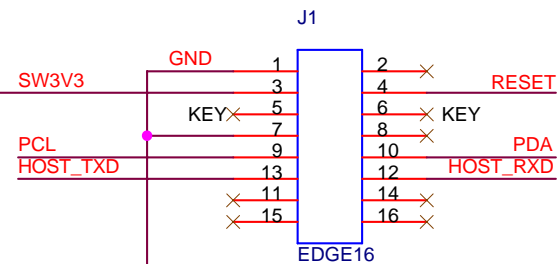
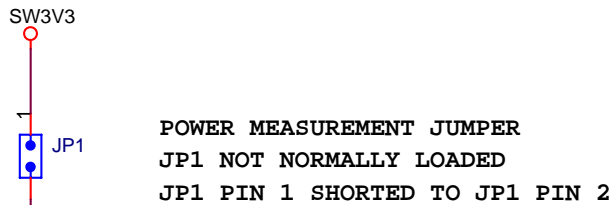
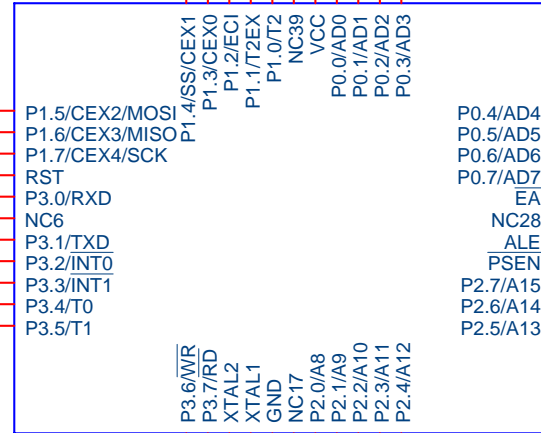
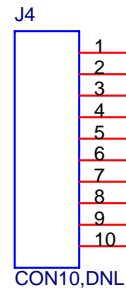
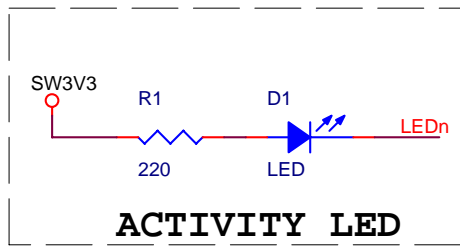
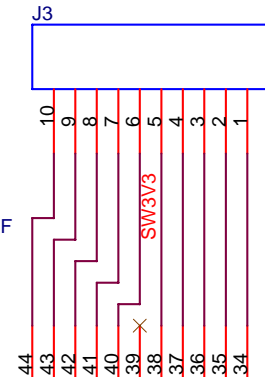
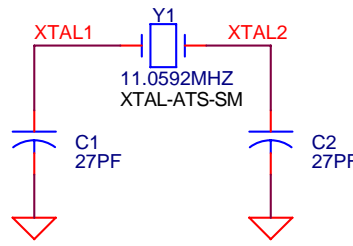

CONNECTOR TO USB-DONGLE

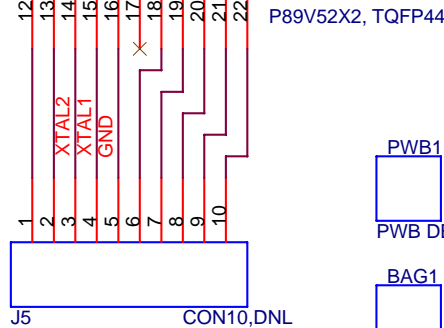

PWB1

PWB DB-TQFP44 2L

BAG1

ANTISTATIC 1.5x5

LBL1

PRODUCT LABEL, DB-TQFP44

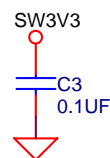

Future Designs, Inc. Huntsville, AL		
Title DB-TQFP44		
Size	Document Number	Rev 1
Date:	Friday, May 18, 2007	Sheet 1 of 1